

GB**English, 1****SX 1049Q CX
SX 1049L CX**

Contents

Installation, 2-3

Positioning
Electrical connection
Data plate

Description of the appliance, 4

Overall view
Control panel
Display in programming mode
Display in cooking mode

Start-up and use, 5-7

Switching the oven on for the first time
Settings menu commands
Control panel lock
Setting the clock
Setting the minute minder
Starting the oven
DEMO mode
Restoring the factory settings
Standby

Modes, 8-14

Manual cooking modes
Automatic cooking modes
Programming cooking
Practical cooking advice
Cooking advice table

Precautions and tips, 15

General safety
Disposal
Respecting and conserving the environment

Care and maintenance, 16-17

Switching the appliance off
Cleaning the appliance
Cleaning the oven door
Replacing the light bulb
Assembling the sliding rack kit

Troubleshooting, 18

After Sales Service, 19

Guarantee, 20

 **Hotpoint**

Please phone us on
08448 24 24 24
to activate your
guarantee

Installation

GB

! Please keep this instruction booklet in a safe place for future reference. If the appliance is sold, given away or moved, please make sure the booklet is also passed on to the new owners so that they may benefit from the advice contained within it.

! Please read this instruction manual carefully: it contains important information on installation, operation and safety.

Positioning

! Do not let children play with the packaging material; it should be disposed of in accordance with local separated waste collection standards (see *Precautions and tips*).

! The appliance must be installed by a qualified person in compliance with the instructions provided. Incorrect installation may damage property or cause harm to people or animals.

Built-in appliances

Use an appropriate cabinet to ensure that the appliance functions properly.

- The panels adjacent to the oven must be made of heat-resistant material.
- Cabinets with a veneer exterior must be assembled with glues which can withstand temperatures of up to 100°C.
- To install the oven under the counter (see *diagram*) or in a kitchen unit, the cabinet must have the following dimensions:

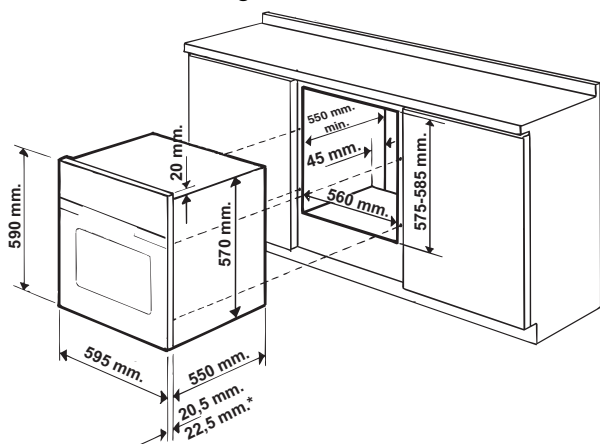

* Stainless steel models only

! The appliance must not come into contact with electrical parts once it has been installed. The indications for consumption given on the data plate have been calculated for this type of installation.

Ventilation

To ensure adequate ventilation is provided, the back panel of the cabinet must be removed. It is advisable to install the oven so that it rests on two strips of wood, or on a completely flat surface with an opening of at least 45 x 560 mm (see *diagrams*).

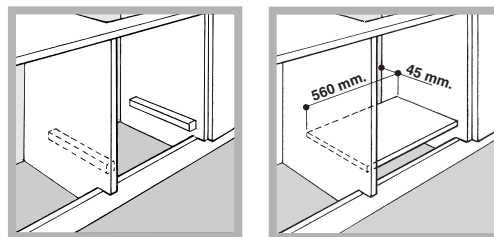

Centring and fixing

Secure the appliance to the cabinet:

- Open the oven door.
- Remove the 2 rubber plugs covering the fixing holes on the perimeter frame.
- Fix the oven to the cabinet using the 2 wood screws.
- Replace the rubber plugs.

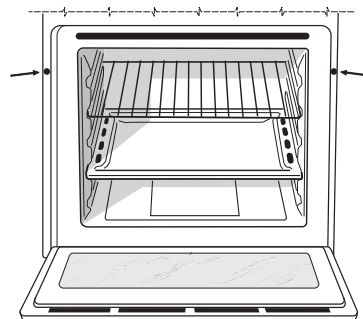

! All parts which ensure the safe operation of the appliance must not be removable without the aid of a tool.

Electrical connection

The electrical connection to the mains must be made on the appliance. The power voltage and frequency are as indicated on the rating plate.

! THIS APPLIANCE MUST BE EARTHED.

Connecting the power supply cable

To open the terminal board:

- Using a screwdriver, press on the tabs situated on each side of the terminal board cover.
- Pull open the terminal board cover.

To connect the power supply cable, proceed as follows:

- Unscrew the cable clamp screw and the contact screws L-N- \perp .
- Fasten the wires beneath the screwheads using the following colour scheme: **Blue (N)** **Brown (L)** **Yellow-Green \perp**
- Fasten the power supply cable in the corresponding cable clamp and close the cover.

Electrical Connection:

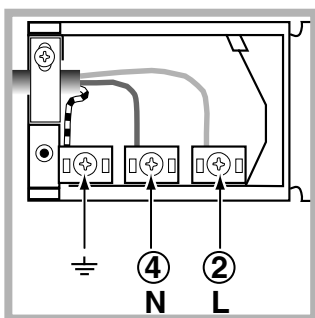

Voltage Frequency: 230 V-1+N 50Hz
 Fuse Section: 16A
 Supply cable: 3x1.5mm²

You can connect your oven to the system means of a terminal board. Refer to above information for the minimal cable sections and the calibration of the protective elements according to the connection. If the appliance is installed **with a junction box**, an **omnipolar circuit breaker** - with a minimum contact opening of 3mm - should be installed between the appliance and the mains.

Power cable supply connection to the electrical mains:

We recommend you use a power supply cable which is long enough to allow you to take the oven out of its recess in the event of maintenance operations (only use HAR - H 05 - RRF quality cables fitted with a plug conforming to the regulations in force. The plug must be accessible at all times.

Unplug the appliance before all operations, even when replacing the oven lamp.

Using the appliance without correct earthing is highly dangerous.

! After connecting the appliance to the flexible cable, tighten all the screws on the terminal board.

APPLIANCE SPECIFICATIONS	
Dimensions	width 43.5 cm height 32 cm depth 41.5 cm
Volume	58 l
Electrical connections	voltage: 230 - 240 V~ 50/60 Hz (see data plate) maximum power absorbed 2800-3000 W
ENERGY LABEL*	Directive 2002/40/EC on the label of electric ovens. Standard EN 50304 Declared energy consumption for Forced convection Class – heating mode: ECO.
	This appliance conforms to the following European Economic Community directives: 2006/95/EEC dated 12/12/06 (Low Voltage) and subsequent amendments - 2004/108/EEC dated 15/12/04 (Electromagnetic Compatibility) and subsequent amendments - 93/68/EEC dated 22/07/93 and subsequent amendments. - 2002/96/EEC and subsequent amendments. - 1275/2008 standby/off mode

* Without removable guide rails

Description of the appliance

GB

Overall view

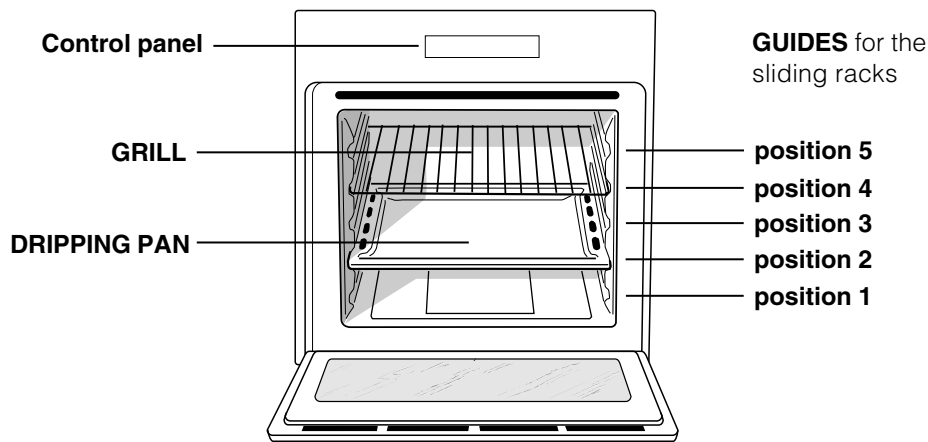

Control panel

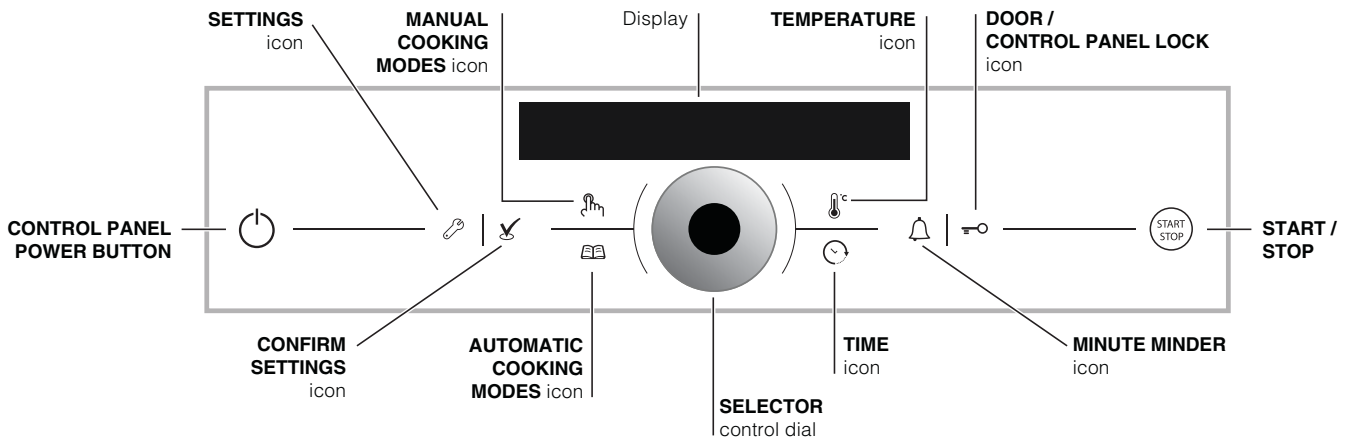

Display in programming mode

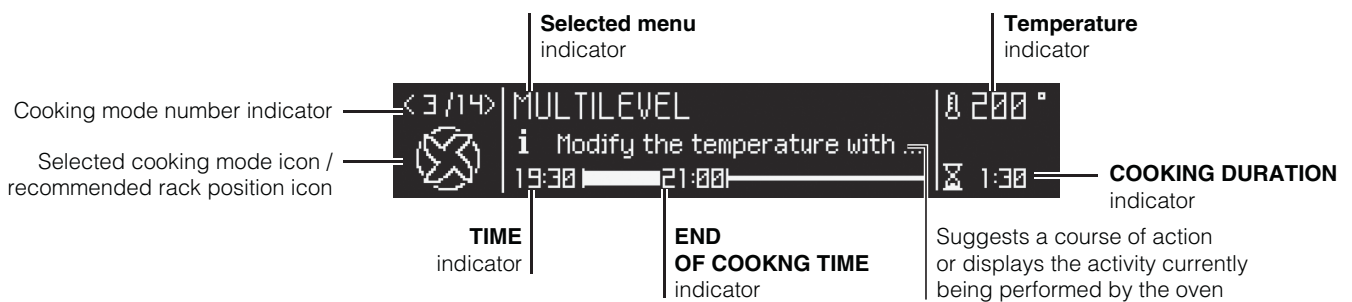

Display in cooking mode

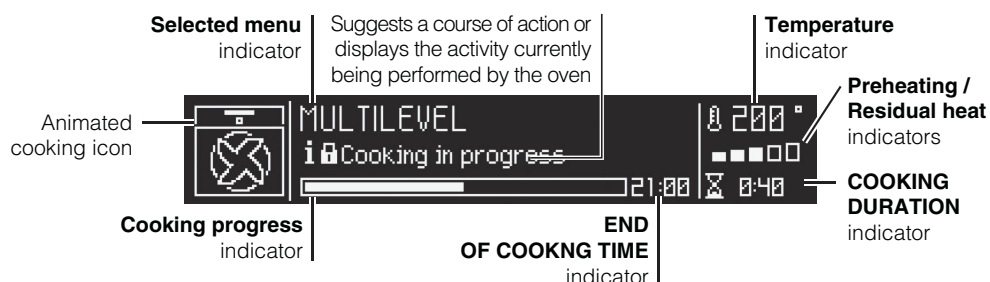

! The first time you use your appliance, heat the empty oven with its door closed at its maximum temperature for at least half an hour. Make sure that the room is well ventilated before switching the oven off and opening the oven door. The appliance may emit a slightly unpleasant odour caused by protective substances used during the manufacturing process burning away.

! Turn the control dial to adjust the parameter shown on the display between the "<" and ">" symbols.

! To make the setting process easier, keep the control dial in position: this will increase the scrolling speed of the numbers on the display.

! Each setting will automatically be stored in the appliance memory after 10 seconds.

! The touch controls cannot be activated if the user is wearing gloves.

Some models are equipped with a system of hinges which allows the door to close slowly, without the user having to follow the movement through with his/her hand. To use the system correctly, before closing the door:

- Open the door fully.
- Do not force the closing movement manually.

Switching the oven on for the first time

After connecting the oven to the electricity supply, the first time it is switched on the user should also

switch on the control panel by pressing the  button. The list of languages will appear in the menu. To choose the desired language, select it

using the control dial. Confirm by pressing the  icon.

Once the selection has been made, the display will show the settings menu. Press the  icon or scroll through using the control dial until you reach the

EXIT command and press the  icon to begin using the oven.

! After choosing the language in the menu, if the display is not used for another 30 seconds it will automatically revert to programming mode.

Settings menu commands

To enter the settings menu, switch on the control panel and press the  icon.

Use the control dial to highlight the individual menu

commands.

To modify the setting, press the  icon.

The following parameters are listed in the menu: LANGUAGE: select the language shown on the display.

CLOCK: set the exact time.

TONE: activate/deactivate keypad tone.

LIGHT: activate/deactivate the internal oven light during cooking.

LOGO: activate/deactivate logo on start-up.

GUIDE: activate/deactivate operating tips.

EXIT: exit the menu.

! It is possible to exit the settings menu by pressing the  icon.

Control panel lock

! The control panel can be locked while the oven is off, once cooking has started or finished and during programming.

The control panel lock can be used to lock the controls.

To activate it, press the  icon and select the desired command by pressing the control dial:

- NO LOCK: deactivate an active lock;
- BUTTONS: lock the controls;

Confirm by pressing the  icon.

A confirmation buzzer will sound and the  icon will appear on the display.

The lock may be activated while the oven is in use, or while it is switched off. It can also be deactivated in all the above situations and after the oven has finished cooking.

Setting the clock

To set the clock, switch on the oven by pressing the .

icon, then press  and follow the steps described.

1. Scroll through the menu commands using the

control dial, select CLOCK and press .

2. Adjust the time using the control dial.

3. Once you have reached the correct hour value,

press the .

4. Repeat steps 2 and 3 to set the minutes.

5. To exit adjustment mode, press the  icon or use the control dial to scroll through the menu until

you reach EXIT, then press .

! The clock can also be set while the oven is off, by pressing the  icon and carrying out steps 2 to 4

as described above.



After the appliance has been connected to the mains, or after a blackout, the clock will need to be reset.

Setting the minute minder

! The minute minder may be set regardless of whether the oven is switched on or off. It does not switch the oven on or off.



When the set time has elapsed, the minute minder emits a buzzer that will automatically stop after 30 seconds or when any active button on the control panel is pressed.

To adjust the minute minder, proceed as follows:

1. Press the  icon.
2. Set the desired time using the control dial.
3. Once you have reached the desired value, press the  icon again.



When the oven is switched off, the countdown appears

on the display. When the oven is on, the lit  symbol will remind you that the minute minder is active.

To cancel the minute minder, press the  icon and use the control dial to set the time to 00:00. Press  again.

The  icon will switch off to indicate that the minute minder has been disabled.

Starting the oven



1. Press  to switch on the control panel. The appliance buzzer sounds three times (ascending).
2. Press the  icon to select the desired manual cooking mode. The cooking temperature and duration may be set.

Press the  icon to select the desired automatic cooking mode. The cooking temperature and duration are both set to default values. Only the duration may be adjusted in accordance with the selected mode. The text "AUTO" appears on the display to indicate that the temperature is following a precise cooking profile. A delayed cooking cycle may be programmed.

3. Press  to start the cooking mode.
4. The oven will begin its preheating phase, the preheating indicators will light up as the temperature rises.
5. When the preheating process has finished, a buzzer sounds and all the preheating indicator lights show that this stage has been completed: the food

can then be placed in the oven.

6. During cooking it is always possible to:

- adjust the temperature by pressing the  icon, turning the control dial and confirming by pressing  again (manual modes only);
- set the duration of a cooking mode (*see Cooking Modes*);

- stop cooking by pressing the  icon. In this case the appliance stores the temperature modified previously in its memory (manual modes only);

- switch off the oven by pressing the  icon for 3 seconds.

7. If a blackout occurs while the oven is already in operation, an automatic system within the appliance will reactivate the cooking mode from the point at which it was interrupted, provided that the temperature has not dropped below a certain level. Programmed cooking modes which have not yet started will not be restored and must be reprogrammed (for example: a cooking mode has been programmed to start at 20:30. At 19:30 a blackout occurs. When the power supply is restored, the mode will have to be reprogrammed).

- ! There is no preheating stage for the GRILL mode.
- ! Never put objects directly on the bottom of the oven; this will prevent the enamel coating from being damaged.
- ! Always place cookware on the rack(s) provided.

Cooling ventilation

In order to cool down the external temperature of the oven, a cooling fan blows a stream of air between the control panel and the oven door, as well as towards the bottom of the oven door. At the beginning of the cleaning cycle, the cooling fan operates at low speed.

! Once cooking has been completed, the cooling fan continues to operate until the oven has cooled down sufficiently.

Oven light

The light comes on when a cooking mode starts (*if enabled in the settings menu*).

When models featuring *LED INSIDE* technology begin cooking, the LEDs on the door light up for improved illumination of all cooking levels.

Residual heat indicators

The appliance is fitted with a residual heat indicator. When the oven is off, the "residual heat" bar on the display lights up to indicate high temperatures inside the oven cavity. The individual segments of the bar switch off one by one as the temperature

inside the oven falls.

Demo mode

! The appliance will not enter DEMO mode if the language has not been selected beforehand.

The oven can operate in DEMO mode: all heating elements are deactivated, and the controls remain operative.

To activate DEMO mode, switch off the oven and keep the control dial turned clockwise while pressing

 for 10 seconds. A buzzer sounds and the display shows "DEMO".

To deactivate DEMO mode, keep the control dial turned anticlockwise while pressing  for 3 seconds. A buzzer sounds to confirm deactivation.

Restoring the factory settings

The oven factory settings can be restored to reset all selections made by the user (language, tone, customised durations, etc...). To carry out a reset,

switch off the oven, then press and hold 6  

and  simultaneously for 6 seconds. Once the restore procedure is complete, a buzzer will sound.

The first time the  icon is pressed, the oven will behave as if it is being switched on for the first time.

Standby

This product complies with the requirements of the latest European Directive on the limitation of power consumption in standby mode. If no buttons are pressed for 30 minutes and the control panel/door lock has not been activated, the appliance automatically reverts to standby mode. The ECO Mode symbol appears on the display to indicate standby mode. As soon as interaction with the machine resumes, system operation is restored.



Modes

GB

! Every time the oven is switched on, it suggests the first manual cooking mode.

Manual cooking modes

! All cooking modes have a default cooking temperature which may be adjusted manually to a value between 40°C and 250°C as desired. In the GRILL mode, the default power level value is indicated as a percentage (%) and may also be adjusted manually. Any temperature adjustments will be stored in the appliance memory and suggested again the next time this mode is used. If the selected temperature is lower than the temperature inside the oven, the text "OVEN TOO HOT" appears on the display. However, it will still be possible to start cooking. If cooking is started without a duration being set, the display will show the elapsed time.



MULTILEVEL mode

All heating elements and the fan are activated. Since the heat remains constant throughout the oven, the air cooks and browns food in a uniform manner. A maximum of two racks may be used at the same time.



GRILL mode

By pressing the  button, the different power levels which may be set will appear on the display; these range between 50% and 100%. The high and direct temperature of the grill is recommended for food which requires a high surface temperature. Always cook in this mode with the oven door closed (see "Practical cooking advice").



FAN GRILLING mode

The top heating element and the rotisserie spit (where present) are activated and the fan begins to operate. During part of the cycle the circular heating element is also activated. This combination of features increases the effectiveness of the unidirectional thermal radiation provided by the heating elements through the forced circulation of the air throughout the oven. This helps prevent food from burning on the surface and allows the heat to penetrate right into the food. Always cook in this mode with the oven door closed (see "Practical cooking advice").



ROAST mode

The top and circular heating elements switch on and the fan begins to operate. This combination of features increases the effectiveness of the unidirectional thermal radiation provided by the heating elements through the forced circulation of the air throughout the oven. This

helps prevent food from burning on the surface and allows the heat to penetrate right into the food. Always cook in this mode with the oven door closed.



FISH mode

The top and circular heating elements switch on and the fan begins to operate. This combination is ideal for cooking fish dishes gently.



PIZZA mode

The top and circular heating elements switch on and the fan begins to operate. This combination heats the oven rapidly. If you use more than one rack at a time, switch the position of the dishes halfway through the cooking process.



PROVING mode

The circular heating element will come on and the fan will operate during the preheating stage only. The oven temperature is ideal for activating the rising process. Always cook in this mode with the oven door closed.



PASTRY mode

The rear heating element and the fan are switched on, thus guaranteeing the distribution of heat in a delicate and uniform manner throughout the entire oven. This mode is ideal for baking temperature sensitive foods (such as cakes, which need to rise).



PASTEURISATION mode

This cooking mode is suitable for fruit, vegetables, etc... Small containers may be positioned on 2 levels (dripping pan on the 1st shelf and rack on the 3rd shelf). Let the containers cool inside the oven. Place the food inside the oven while it is still cold.



SLOW COOK MEAT/FISH/VEGETABLES modes

This type of cooking mode, used for years by industry professionals, enables food (meat, fish, fruit and vegetables) to be cooked at very low temperatures (75, 85 and 110°C), thereby guaranteeing a perfect level of cooking and enhancing the taste as much as possible. The value of these advantages should not be underestimated:

- as the cooking temperatures are very low (in general they are lower than the temperature required for evaporation), the dispersion of cooking sauces due to evaporation is substantially reduced and the food becomes softer;

- when cooking meat, the muscle fibres contract less than they would during a classic cooking cycle. The result is a more tender meat which does not need to be rested after it is cooked. Meat should be browned before it is placed in the oven.

Cooking foods which have been vacuum-packed at low temperatures, a technique used for over 30 years by the most prestigious chefs, brings many advantages:

- culinary: flavours are concentrated and the taste, softness and tenderness of the food are maintained;
- hygienic: provided that hygiene regulations are respected, this type of cooking protects the food from the harmful effects of oxygen, thus ensuring that the dishes may be stored for longer in the refrigerator;
- organisational: thanks to the longer storage period, dishes may be prepared well in advance;
- diet-related: this type of cooking limits the amount of fatty substances used and therefore means that the food is lighter and easier to digest;
- financial: the food shrinks less so there is more of the product left after it has been cooked.

To use this technique, you must use a vacuum-packing machine and the appropriate bags. Follow the instructions supplied relating to vacuum-packing food carefully.

The vacuum-packing technique may also be used for raw products (fruit, vegetables, etc.) as well as pre-cooked products (traditional cooking).

DEFROSTNG mode

The fan at the bottom of the oven circulates room-temperature air around the food. This mode is suitable for defrosting any type of food, especially delicate items that should not be heated, for example: ice-cream cakes or cakes made with custard, cream or fruit.

ECO mode



The rear heating element and the fan are switched on, thus guaranteeing the distribution of heat in a delicate and uniform manner throughout the entire oven. This energy saving mode is recommended for small dishes, ideal for heating foods and finishing off cooking.

* Only available in certain models.

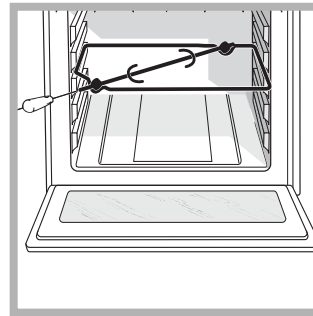
Rotisserie spit*



the back panel of the oven.

1. Place the dripping pan in position 1.
2. Place the rotisserie support in position 3 and insert the spit in the hole provided on
3. Start the rotisserie function by selecting the  or  modes.

To operate the rotisserie function (*see diagram*) proceed as follows:

Automatic cooking modes

! The temperature and cooking duration are pre-set, guaranteeing a perfect result every time - automatically. These values are set using the C.O.P.® (Programmed Optimal Cooking) system. The cooking cycle stops automatically and the oven indicates when the dish is cooked. You may start cooking whether the oven has been preheated or not. The cooking duration can be customised according to personal tastes, modifying it by $\pm 5/10$ minutes depending on the selected programme. If the value is modified before cooking begins, it is stored in the appliance memory and suggested again when that cooking mode is next used. If the temperature inside the oven is higher than the suggested value for the selected mode, the text "OVEN TOO HOT" appears on the display and it will not be possible to begin cooking; wait for the oven to cool.

The icon representing the selected mode and the icon representing the recommended shelf position appear on the display alternately.

! When the cooking stage has been reached, the oven buzzer sounds.

! Do not open the oven door as this will disrupt the cooking time and temperature.



BREAD mode

Use this function to bake bread. To obtain the best results, we recommend that you carefully observe the instructions below:

- Follow the recipe.
- Do not exceed the maximum weight of the dripping pan.
- Remember to pour 50 g (0,5 dl) of cold water into the baking tray in position 5.

- The dough must be left to rise at room temperature for 1 – 1 ½ hours (depending on the room temperature) or until the dough has doubled in size.

Recipe for BREAD:

1 dripping pan holding 1000 g max, lower level
2 dripping pans each holding 1000 g max, medium and lower levels



Recipe for 1000 g of dough: 600 g flour, 360 g water, 11g salt, 25 g fresh yeast (or 2 sachets of powder yeast)

Method:

- Mix the flour and salt in a large bowl.
- Dilute the yeast in lukewarm water (approximately 35 degrees).
- Make a small well in the mound of flour.
- Pour in the water and yeast mixture.
- Knead the dough by stretching and folding it over itself with the palm of your hand for 10 minutes until it has a uniform consistency and is not too sticky.
- Form the dough into a ball shape, place it in a large bowl and cover it with transparent plastic wrap to prevent the surface of the dough from drying out. Select the manual PROVING function on the oven. Place the bowl inside and leave the dough to rise for approximately 1 hour (the dough should double in volume).
- Cut the dough into equal sized loaves.
- Place them in the dripping pan, on a sheet of baking paper.
- Dust the loaves with flour.
- Make incisions on the loaves.
- Place the food inside the oven while it is still cold.
- Start the  BREAD cooking mode.
- Once baked, leave the loaves on one of the grill racks until they have cooled completely.

BEEF/VEAL/LAMB mode

Use this function to cook beef, veal and lamb. Place the food inside the oven while it is still cold. The dish may also be placed in a preheated oven. Some of the ROAST modes offer the option of selecting the desired cooking level:

1. Press the  icon.
2. Use the control dial to select "WELL DONE", "MEDIUM" or "RARE".
3. Press  again.

PORK mode

Use this function to cook pork. Place the food inside the oven while it is still cold. The dish may also be placed in a preheated oven.

CHICKEN mode

This function is ideal for cooking chicken (whole or in pieces). Place the food inside the oven while it is still

cold. The dish may also be placed in a preheated oven.

FISH FILLET mode

This function is ideal for cooking small-medium fillets. Place the food inside the oven while it is still cold.

FISH EN PAPILOTE mode

Use this function to cook whole fish with a maximum weight of 1 kg. The paper/foil package can be placed directly on the dripping pan. Place the food inside the oven while it is still cold.

TARTS mode

This function is ideal for all tart recipes (which normally need to be heated well from underneath). Place the food inside the oven while it is still cold. The dish may also be placed in a preheated oven.

SHORTCRUST TARTS mode

This function is ideal for all recipes which require shortcrust pastry (usually made without eggs) or have a liquid or very soft filling. Place the food inside the oven while it is still cold. The dish may also be placed in a preheated oven.

BRIOCHE mode

This function is ideal for baked desserts (made using natural yeast). Place the food inside the oven while it is still cold; the dish may also be placed in a preheated oven if desired.

CAKE mode

This function is ideal for all recipes made using baking powder. Place the food inside the oven while it is still cold. The dish may also be placed in a preheated oven.

DESSERTS mode

This function is ideal for cooking desserts which are made using natural yeast, baking powder and desserts which contain no yeast. Place the dish in the oven while it is still cold. The dish may also be placed in a preheated oven.

PAELLA mode

This function was designed for quick and easy paella preparation; all ingredients are placed inside the oven while it is still cold. To obtain the best results, we recommend that you carefully observe the instructions below:

- The rice used must not be sticky: salad rice or American long-grain rice are particularly suitable.
- The oven must not be preheated.
- Position:
 - the deep dripping pan on shelf level 1 (if supplied as an accessory), or place the rack on shelf level 1 and stand a dish measuring

approximately 35x30cm (height 5 cm) on it;
 - the dripping pan on shelf level 3;
 - the rack on shelf level 5;

Recipe (serves 8):

In the deep dripping pan

- 1 onion, chopped
- 500 g rice
- 500 g frozen mixed seafood (shelled prawns, mussels and clams, squid rings, etc.)
- 2 handfuls frozen peas
- ¼ chilli, diced
- Chorizo (spiced paprika sausage), sliced
- One tbsp fish stock powder
- 1 measure powdered saffron
- 700 g water

Cover the dripping pan with aluminium foil.

In the dripping pan

- 8 fish fillet portions (choose type according to your personal taste)
- 8 (or 16) king prawns (or scampi)
- Whole mussels, to garnish
- ½ cup water

Cover the dripping pan with aluminium foil.

On a tray standing on the rack

- 8 chicken thighs, marinated using paella spices and a drizzle of olive oil



PILAU RICE mode

Use this function to cook rice. To obtain the best results, we recommend that you observe the instructions below:

- The rice used must not be sticky: salad rice or American long-grain rice are particularly suitable.
- The oven must not be preheated.
- The deep dripping pan should be on shelf level 2 (if supplied as an accessory), or the rack placed on shelf level 2 and a dish measuring approximately 35x30cm (height 5 cm) stood on it.

Recipe (serves 4 - 6):

- 500 g rice
- 700 ml water or stock

Place the rice in the deep dripping pan without soaking and cover with liquid. Cover the dripping pan with the aluminium foil.



YOGHURT mode

The circular heating element will come on and the fan will operate during the preheating stage only. The temperature of 50°C is ideal for preparing yoghurt.

Basic recipe for one litre of yoghurt: one litre of whole UHT milk, one pot of natural yoghurt



Method:

- Heat the milk in a steel pan until it reaches boiling point.
- Remove the layer of cream on the surface and leave to cool.
- Stir 3 or 4 tablespoons of milk into the yoghurt and combine well.
- Add the mixture to the remaining milk and mix thoroughly.
- Pour into airtight jars.
- Stand the jars on the dripping pan and place in the oven, on level 2.
- When cooking is complete, store the yoghurt in the refrigerator for up to one week.
- The recipe can be adjusted to taste.

Programming cooking

! A cooking mode must be selected before programming can take place.

Programming the duration

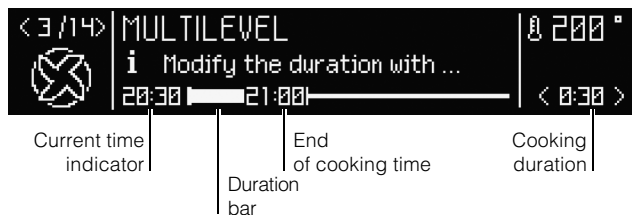

1. Press the  icon.
2. Turn the control dial to set the duration; hold the dial in this position to scroll through the numbers more quickly and make the setting process easier. The display will show a graphic indicating the duration in bar format.
3. Once you have reached the desired duration, press the  icon again. The duration bar will show the current time, the duration and the end of cooking time as a graphic.
4. Press  to begin cooking.
5. The display will indicate the remaining time by filling the duration bar.
6. When cooking has finished, "COOKING FINISHED" appears on the display and a buzzer sounds.
 - For example: it is 9:00 a.m. and a duration of 1 hour and 15 minutes is programmed. The programme will stop automatically at 10:15 a.m.



Programming delayed cooking

! A cooking duration must be set before the end of cooking time can be scheduled.

! For the delayed programming to work properly, the clock should be set to the correct time.

1. Follow steps 1 to 3 to set the duration as detailed above.
2. Press the  icon twice; the end of cooking time will begin to flash.
3. Turn the control dial to adjust the end of cooking time; hold the dial in this position to scroll through the numbers more quickly and make the setting process easier. The display will show a graphic indicating the delayed start in bar format.
4. Once you have reached the desired end time, press the  icon again. The delayed start bar will show the current time, the time remaining until the start of cooking, the duration and the end of cooking time as a graphic.
4. Press  to begin the pyrolysis schedule.

5. The text "POSTPONED COOKING START" and the time remaining will appear on the display, moving the delayed start bar backwards.
6. Once cooking has begun, the display will indicate the remaining time by filling the duration bar.
7. When the time has elapsed, "COOKING FINISHED" appears on the display and a buzzer sounds.
 - For example: it is 9:00 a.m. and a time of 1 hour and 15 minutes is programmed, while the end time is set to 12:30. The programme will start automatically at 11:15 a.m.



To cancel a schedule, press the  icon.

Practical cooking advice

! Do not place racks in position 1 and 5 during fan-assisted cooking. This is because excessive direct heat can burn temperature sensitive foods.

! In the GRILL and FAN GRILLING cooking modes, particularly when using the rotisserie spit, place the dripping pan in position 1 to collect cooking residues (fat and/or grease).

MULTILEVEL

- Use positions 2 and 4, placing the food which requires more heat on 2.
- Place the dripping pan on the bottom and the rack on top.

GRILL

- Place the rack in position 3 or 4. Position the food in the centre of the rack.
- We recommend that the temperature is set to its maximum level. The top heating element is regulated by a thermostat and may not always operate constantly.

PIZZA

- Use a lightweight aluminium pizza pan. Place it on the rack provided.
For a crispy crust, do not use the dripping pan as this extends the total cooking duration and prevents the crust from forming.
- If the pizza has a lot of toppings, we recommend adding the mozzarella cheese to the top of the pizza halfway through the cooking process.

Cooking advice table

Modes	Foods	Weight (in kg)	Rack position		Preheating	Recommended Temperature (°C)	Cooking duration (minutes)
			Standard guide rails	Sliding guide rails			
Manual							
Multilevel*	Pizza on 2 racks		2 and 4	1 and 3	yes	220-230	20-25
	Pies on two racks/cakes on 2 racks		2 and 4	1 and 3	yes	180	30-35
	Sponge cake on 2 racks (on the dripping pan)		2 and 4	1 and 3	yes	170	20-25
	Roast chicken + potatoes	1+1	1 and 2/3	1 and 3	yes	200-210	65-75
	Lamb	1	2	1	yes	190-200	45-50
	Mackerel	1	1 or 2	1	yes	180	30-35
	Lasagne	1	2	1	yes	190-200	35-40
	Cream puffs on 3 racks		1 and 3 and 5	1 and 2 and 4	yes	190	20-25
	Biscuits on 3 racks		1 and 3 and 5	1 and 2 and 4	yes	190	10-20
	Cheese puffs on 2 racks		2 and 4	1 and 3	yes	210	20-25
	Savoury pies		1 and 3	1 and 3	yes	200	20-30
Grill*	Mackerel	1	4	3	no	100%	10-20
	Sole and cuttlefish	0,7	4	3	no	100%	10-15
	Squid and prawn kebabs	0,7	4	3	no	100%	10-15
	Cod fillet	0,7	4	3	no	100%	10-15
	Grilled vegetables	0,5	3 or 4	2 or 3	no	100%	15-20
	Veal steak	0,8	4	3	no	100%	10-20
	Sausages	0,7	4	3	no	100%	10-20
	Hamburgers	n° 4 or 5	4	3	no	100%	10-12
	Toasted sandwiches (or toast)	n° 4 or 6	4	3	no	100%	3-5
	Spit-roast chicken using rotisserie spit (where present)	1	-	-	no	100%	70-80
	Spit-roast lamb using rotisserie spit (where present)	1	-	-	no	100%	70-80
Fan grilling*	Grilled chicken	1,5	2	2	no	210	55-60
	Cuttlefish	1	-	2	no	200	30-35
	Spit-roast chicken using rotisserie spit (where present)	1,5	-	-	no	210	70-80
	Spit-roast duck using rotisserie spit (where present)	1,5	-	-	no	210	60-70
	Roast veal or beef	1	2	2	no	210	60-75
	Roast pork	1	2	2	no	210	70-80
	Lamb	1	2	2	no	210	40-45
Roast*	Roasts (white or red meat)	1	2	2	no	200	50-75
Fish*	Bream	0,7	2	2	yes	180	20-25
	Fish fillets	1	2	2	yes	170	12-15
	Sea bass with potatoes	0,5 + 0,5	2	2	yes	190	60
Pizza*	Pizza	0,5	2	1	yes	220	15-20
	Focaccia bread	0,5	2	1	yes	200	20-25
Proving*	Rising process for dough made with yeast (brioches, bread, sugar pie, croissants, etc.).		2	2	no	40	
ECO*	Tarts	0,5	2 or 3	1 or 2	yes	200	30-40
	Small cakes on 2 racks	0,7	2 and 4	1 and 3	yes	200	20-25
	Sponge cake	0,6	2 or 3	1 or 2	yes	180	35-40
	Biscuits on 2 racks	0,7	1 and 3	1 and 2	yes	200	20-25
	Cheese puffs	0,5	2	1	yes	200	20-30
	Meringues on 2 racks	0,5	1 and 3	1 and 2	yes	90	180
	Fish fillets	0,5	2 or 3	1 or 2	yes	200	20-25
	Lamb skewers	0,5	2 or 3	1 or 2	yes	200	20-25
	Hamburgers	0,5	2 or 3	1 or 2	yes	200	20-25
Pasteurisation*	Fruit, vegetables, etc.		2	2	yes	110	
Slow cook*	Meat		2	1	no	75	90-180
	Fish		2	1	no	85	90-180
	Vegetables		2	1	no	110	90-180
Defrosting*	All frozen foods						

* The cooking times listed above are intended as guidelines only and may be modified according to personal tastes. Oven preheating times are set as standard and may not be modified manually.

Modes	Foods	Weight (in kg)	Rack position		Preheating
			Standard guide rails	Sliding guide rails	
Automatic*					
Bread**	Bread (see recipe)	1	2 or 3	2	no
Beef	Roast beef	1-1,5	2 or 3	2	no
Veal	Roast veal	1-1,5	2 or 3	2	no
Lamb	Leg of lamb	1-1,5	2 or 3	2	no
Pork	Roast pork	1,2-1,5	2 or 3	2	no
Chicken	Roast chicken	1-1,5	2 or 3	2	no
Fish fillet	Cod	0,4-0,5	2 or 3	2	no
	Perch	0,4-0,5	2 or 3	2	no
	Trout	0,4-0,5	2 or 3	2	no
Fish en papillote	Bream	0,4-0,5	2 or 3	2	no
	Sea bass	0,4-0,5	2 or 3	2	no
Tarts	Tarts	0,5	2 or 3	2	no
Shortcrust tarts	Apple flan	0,5	2 or 3	2	no
Brioche	Desserts made with natural yeast (brioches, almond cake, etc.)	0,7	2 or 3	2	no
Cake	Desserts made with baking powder (marbled biscuits, pound cake, etc.)	0,7	2 or 3	2	no
Desserts	Desserts	1	2 or 3	2	no
Paella	Paella (see recipe)		1-3-5	1-2-4	no
Pilau rice	Pilau rice (see recipe)	0,5	2	1	no
Yoghurt	Yoghurt		2	2	yes

* The duration of the automatic cooking functions are set by default. The values can be modified by the user, starting with the default duration.

** As stated in the recipe, pour 50 g (0,5 dl) water into the dripping pan in position 5.

! This appliance has been designed and manufactured in compliance with international safety standards. The following warnings are provided for safety reasons and must be read carefully.

General safety

- The appliance was designed for domestic use inside the home and is not intended for commercial or industrial use.
- The appliance must not be installed outdoors, even in covered areas. It is extremely dangerous to leave the appliance exposed to rain and storms.
- When moving or positioning the appliance, always use the handles provided on the sides of the oven.
- Do not touch the appliance while barefoot or with wet or damp hands and feet.
- The appliance must be used by adults only for the preparation of food, in accordance with the instructions provided in this booklet. Any other use of the appliance (e.g. for heating the room) constitutes improper use and is dangerous. The manufacturer may not be held responsible for any damage caused as a result of improper, incorrect and unreasonable use of the appliance.
- Do not touch the heating elements or certain parts of the oven door when the appliance is in use; these parts become extremely hot. Keep children well away from the appliance.
- Make sure that the power supply cables of other electrical appliances do not come into contact with the hot parts of the oven.
- The ventilation and heat dispersal openings must never be obstructed.
- Always grip the oven door handle in the centre: the ends may be hot.
- Always use oven gloves when placing cookware in the oven or when removing it.
- Do not use aluminium foil to line the bottom of the oven.
- Do not place flammable materials in the oven: if the appliance is switched on accidentally, the materials could catch fire.
- When unplugging the appliance, always pull the plug from the mains socket; do not pull on the cable.
- Do not perform any cleaning or maintenance work without having disconnected the appliance from the electricity mains.
- If the event of malfunctions, under no circumstances should you attempt to perform the repairs yourself. Contact an authorised Service Centre (*see Assistance*).
- Do not rest objects on the open oven door.
- Do not let children play with the appliance.
- The appliance should not be operated by people

(including children) with reduced physical, sensory or mental capacities, by inexperienced individuals or by anyone who is not familiar with the product. These individuals should, at the very least, be supervised by someone who assumes responsibility for their safety or receive preliminary instructions relating to the operation of the appliance.

Disposal

- When disposing of packaging material: observe local legislation so that the packaging may be reused.
- The European Directive 2002/96/EC relating to Waste Electrical and Electronic Equipment (WEEE) states that household appliances should not be disposed of using the normal solid urban waste cycle. Exhausted appliances should be collected separately in order to optimise the cost of re-using and recycling the materials inside the machine, while preventing potential damage to the atmosphere and to public health. The crossed-out dustbin is marked on all products to remind the owner of their obligations regarding separated waste collection. For further information relating to the correct disposal of exhausted household appliances, owners may contact the relevant public service or their local dealer.

Respecting and conserving the environment

- You can help to reduce the peak load of the electricity supply network companies by using the oven in the hours between late afternoon and the early hours of the morning. The cooking mode programming options, the "delayed cooking" mode (*see Cooking modes*) and "delayed automatic cleaning" mode (*see Care and Maintenance*) in particular, enable the user to organise their time efficiently.
 - Always keep the oven door closed when using the GRILL and FAN GRILLING modes: this will achieve improved results while saving energy (approximately 10%).
 - Check the door seals regularly and wipe them clean to ensure they are free of debris so that they adhere properly to the door, thus avoiding the dispersal of heat.
- ! This product complies with the requirements of the latest European Directive on the limitation of power consumption in standby mode.

Care and maintenance

GB

Switching the appliance off

Disconnect your appliance from the electricity supply before carrying out any work on it.

Cleaning the appliance

- Slight differences in colour on the front of the oven are due to the different materials used, i.e. glass, plastic or metal.
- Any shady areas resembling grooves on the oven door glass are caused by reflections from the oven light.
- The enamel is branded at very high temperatures. This process may cause colour variations. This is normal and will not affect appliance operation in any way. The thin edges of the sheet metal cannot be entirely enamelled and may therefore appear to be unfinished. This will not affect the rust protection.
- The stainless steel or enamel-coated external parts and the rubber seals may be cleaned using a sponge that has been soaked in lukewarm water and neutral soap. Use specialised products for the removal of stubborn stains. After cleaning, rinse and dry thoroughly. Do not use abrasive powders or corrosive substances.
- The inside of the oven should ideally be cleaned after each use, while it is still lukewarm. Use hot water and detergent, then rinse well and dry with a soft cloth. Do not use abrasive products.
- All accessories - with the exception of the sliding racks - can be washed like everyday crockery, and are even dishwasher safe.
- We recommend that detergents are not sprayed directly onto the control panel, but that a sponge is used instead.

! Never use steam cleaners or pressure cleaners on the appliance.

Cleaning the oven door

! The door of **LED INSIDE** models cannot be removed.

Clean the glass part of the oven door using a sponge and a non-abrasive cleaning product, then dry thoroughly with a soft cloth. Do not use rough abrasive material or sharp metal scrapers as these could scratch the surface and cause the glass to crack.

For more thorough cleaning purposes, the oven door may be removed:

1. Open the oven door fully (*see diagram*).
2. Use a screwdriver to lift up and turn the small levers **F** located on the two hinges (*see diagram*).

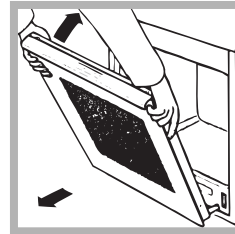
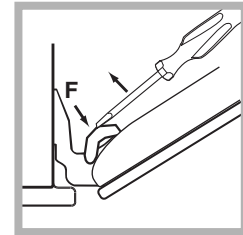
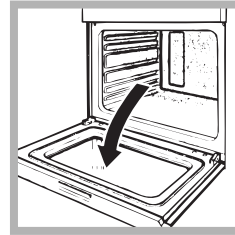

3. Grip the door on the two outer sides and close it approximately half way. Pull the door towards you, lifting it out of its slot (*see diagram*). To replace the door, reverse this sequence.

Inspecting the seals

Check the door seals around the oven regularly. If the seals are damaged, please contact your nearest Service Centre (*see Assistance*). We recommend that the oven is not used until the seals have been replaced.

Replacing the light bulb

To replace the oven light bulb:

1. Remove the glass cover of the lamp-holder.
2. Remove the light bulb and replace it with a similar one: halogen lamp voltage 230 V, wattage 25 W, cap G 9.
3. Replace the glass cover (*see diagram*).

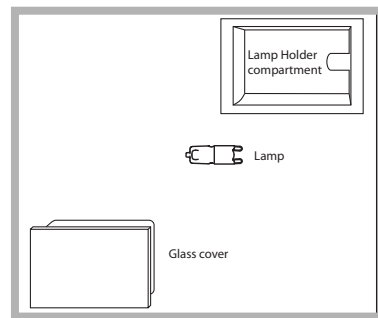

! Do not touch the light bulb directly with your hands.

Sliding rack kit assembly

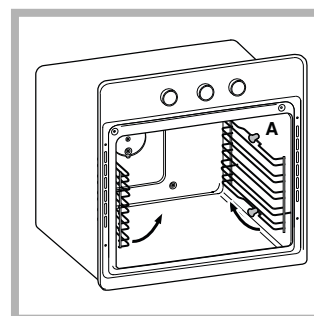

To assemble the sliding racks:

1. Remove the two frames, lifting them away from the spacers **A** (*see figure*).

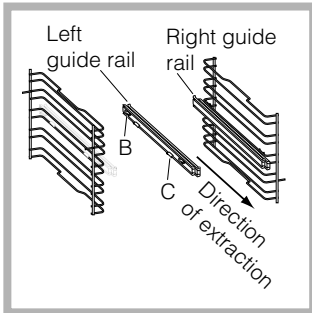

2. Choose which shelf to use with the sliding rack. Paying attention to the direction in which the sliding rack is to be extracted, position joint B and then joint C on the frame.

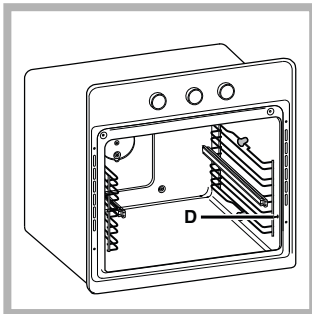

3. Secure the two frames with the guide rails using the holes provided on the oven walls (*see diagram*). The holes for the left frame are situated at the top, while the holes for the right frame are at the bottom.

4. Finally, fit the frames on the spacers A.

! Do not place the sliding racks in position 5.

Side and rear catalytic liners*

These are panels coated with a special enamel, which is able to absorb the fat released by food as it cooks.

This enamel is quite strong, so that the various accessories (racks, dripping pans, etc.) can slide along them without damaging them. White marks may appear on the surfaces; these are not a cause for concern.

Nevertheless, the following should be avoided:

- scraping the enamel with sharp objects (a knife, for example);
- using detergents or abrasive materials.

* Only available in certain models.

Troubleshooting

GB

Problem	Possible cause	Solution
A programmed cooking mode does not start.	There has been a blackout.	Reprogram the cooking mode.
The display shows ECO Mode.	The appliance is in standby mode.	Press any button to exit standby mode.
An automatic mode has been selected. "Hot" appears on the display and cooking does not start.	The temperature inside the oven is higher than the suggested value for the selected mode.	Wait for the oven to cool down.
Fan-assisted cooking has been selected and the food looks burnt.	Positions 1 and 5: the direct heat could cause temperature-sensitive foods to burn.	We recommend switching dripping pan positions halfway through cooking.

After Sales Service

No one is better placed to care for your Hotpoint appliance during the course of its working life than us – the manufacturer.

Essential Contact Information

Hotpoint Service

We are the largest service team in the country offering you access to 400 skilled telephone advisors and 1000 fully qualified engineers on call to ensure you receive fast, reliable, local service.

UK: 08448 224 224
Republic of Ireland: 0818 313 413
www.hotpointservice.co.uk

Please note: Our advisors will require the following information:

Model number:

Serial number:

Parts and Accessories

We supply a full range of genuine replacement parts as well as accessory products that protect and hygienically clean your appliance to keep it looking good and functioning efficiently throughout its life.

UK: 08448 225 225
Republic of Ireland: 0818 313 413
www.hotpointservice.co.uk

Appliance Registration

We want to give you additional benefits of Hotpoint ownership. To activate your free 5 year parts guarantee you must register your appliance with us.

UK: 08448 24 24 24
Republic of Ireland: 01 230 0800
www.hotpointservice.co.uk

Indesit Company UK Ltd. Morley Way, Peterborough, PE2 9JB
Indesit Company Unit 49 Airways Industrial Estate, Dublin 17

Recycling and Disposal Information

As part of Hotpoint's continued commitment to helping the environment, Hotpoint reserves the right to use quality, recycled components to keep down customer costs and minimise material wastage.

Please dispose of packaging and old appliances carefully. To minimise the risk of injury to children, remove the door, plug, and cut the mains cable off flush with the appliance. Dispose of these parts separately to ensure that the appliance can no longer be plugged into mains socket, and the door cannot be locked shut.

Guarantee

12 months Parts and Labour Guarantee

Your appliance has the benefit of our manufacturer's guarantee, which covers the cost of breakdown repairs for twelve months from the date of purchase.

This gives you the reassurance that if, within that time, your appliance is proven to be defective because of either workmanship or materials, we will, at our discretion, either repair or replace the appliance at no cost to you.

This guarantee is subject to the following conditions:

- The appliance has been installed and operated correctly and in accordance with our operating and maintenance instructions.
- The appliance is used only on the electricity or gas supply printed on the rating plate.
- The appliance has been used for normal domestic purposes only.
- The appliance has not been altered, serviced, maintained, dismantled, or otherwise interfered with by any person not authorised by us.
- Any repair work must be undertaken by us or our appointed agent.
- Any parts removed during repair work or any appliance that is replaced become our property.
- The appliance is used in the United Kingdom or Republic of Ireland.

The guarantee does not cover:

- Damage resulting from transportation, improper use, neglect or interference or as a result of improper installation.
- Replacement of any consumable item or accessory. These included but not limited to: plugs, cables, batteries, light bulbs, fluorescent tubes and starters, covers and filters.
- Replacement of any removable parts made of glass or plastic.

THIS GUARANTEE WILL NOT APPLY IF THE APPLIANCE HAS BEEN USED IN COMMERCIAL OR NON-DOMESTIC PREMISES.

5 Year Parts Guarantee

Hotpoint also offers you a free 5 year parts guarantee. This additional guarantee is conditional on you registering your appliance with us and the parts being fitted by one of our authorised engineers. There will be a charge for our engineer's time. To activate the extra parts warranty on your appliance, simply call our registration line on **08448 24 24 24 (Republic of Ireland 01 230 0800)**

Extended Guarantees

We offer a selection of protection plans that enable you to fully cover yourself against the expense of repair bills for the life of your policy. To find the ideal plan for you please call our advice line on **08448 226 226 (Republic of Ireland 01 230 0233)**.

Free Helpdesk Service

We have a dedicated team who can provide free advice and assistance with your appliance if you experience any technical difficulties within the first 90 days of ownership. Simply call our Hotpoint Service Hotline on **08448 224 224 (Republic of Ireland 0818 313 413)** for telephone assistance, or, where necessary, to arrange for an engineer to call.